

Tapón D80

REFERENCIA: TSU-D80



ESPECIFICACIONES TÉCNICAS



PESO
weight

9.5 ± 0.5gr



MATERIAL
material

PP



UDS CAJA
uds box

500

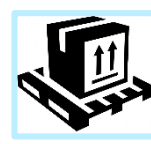

CAJA PALLET
box pallet

20

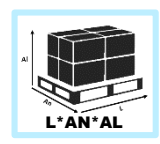

MED. PALLET
pallet sizes

1200*800*2100

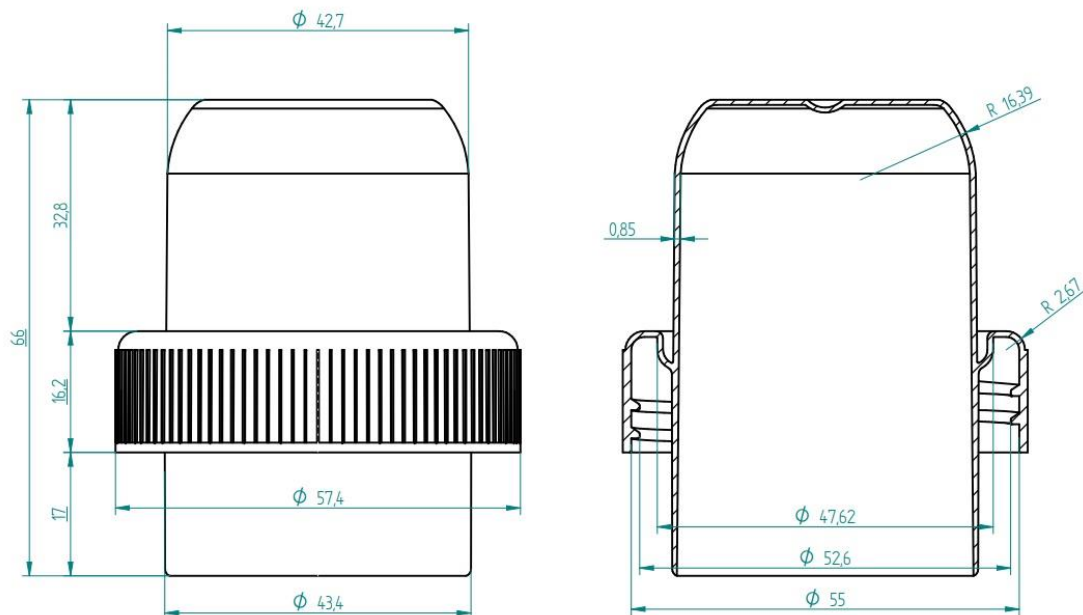

COLORES

colours

